

Pos.	Description
1	EXTERNAL UNIT HHP - MONOBLOC 1 -PH OR 3-PH
2	LIGHTBOX
3	SYSTEM INTERFACE
4	LIGHT GATEWAY
5	EXTERNAL PROBE
6	KIT ANTI-FREEZE
7	MGM II HC
8	EXPANSION VESSEL - HEATING
9	HEATING-DHW 3-WAY VALVE
10	DHW INLET SAFETY GROUP
11	DHW TANK HHP 1-COIL WITH T PROBE AND ANODE
12	UNDER FLOOR HEATING-COOLING
13	FANCOIL HEATING-COOLING
14	BY-PASS VALVE
14	HE KIT BELOW ODU
15	THERMOSTATIC MIXING VALVE

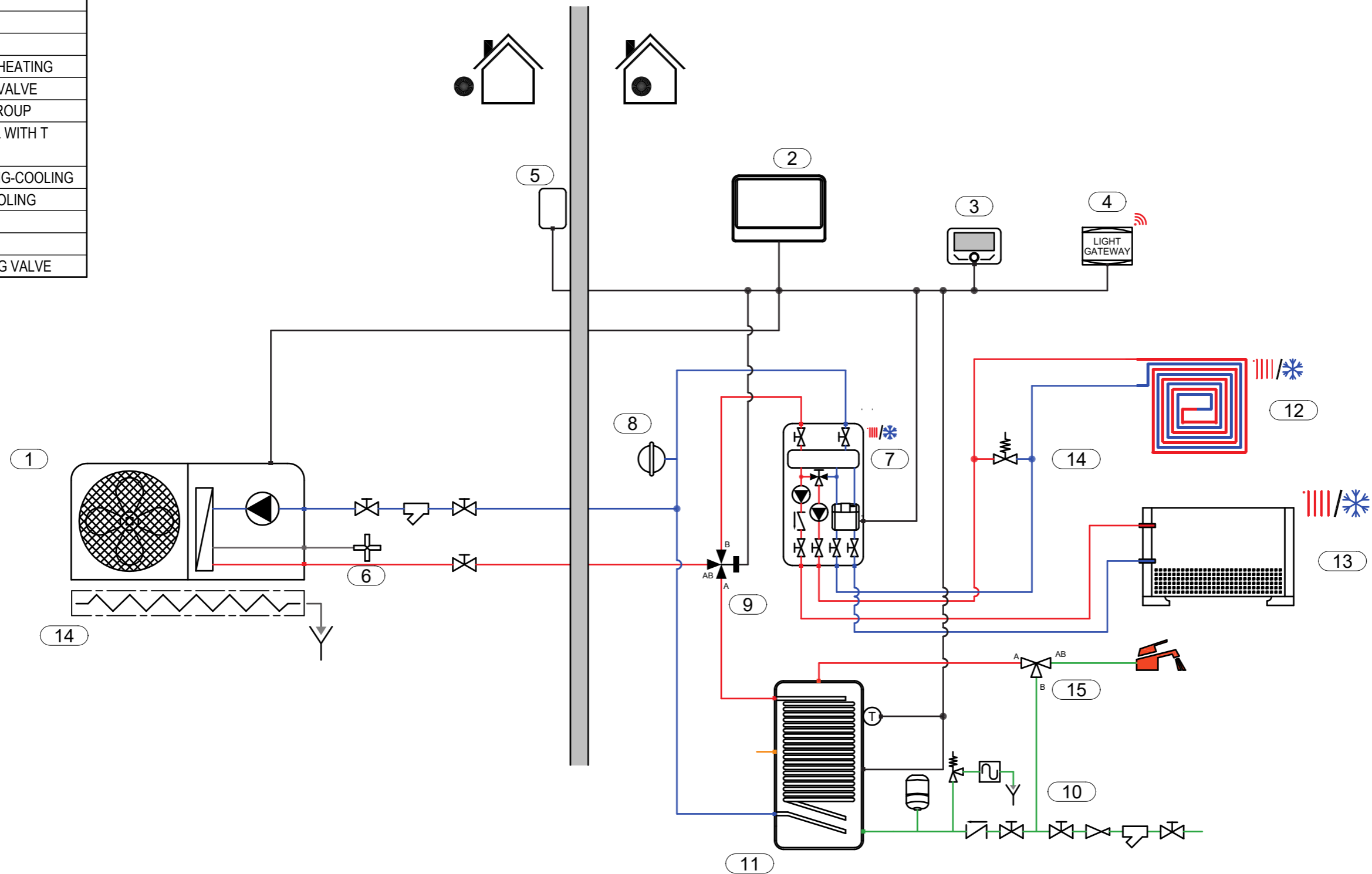

- This schematic is for example only and does not replace design by a qualified technician;
- The final schematic must be prepared respecting all the laws, norms and decrees in force, in order to facilitate a correct installation in compliance with the rule of the art;
- For the proper functioning of all system components, follow the instructions in the design, installation and user manuals provided by the manufacturer;
- This outline may be amended by the Ariston Group at any time without prior notice.

SCHEME Hydraulic		
DATE 19.10.2023.	REV.	PAGE 1 / 3

SCHEME NAME
EN_004_PCM4.PK_HCD_CD1_MGM2_1D.1M



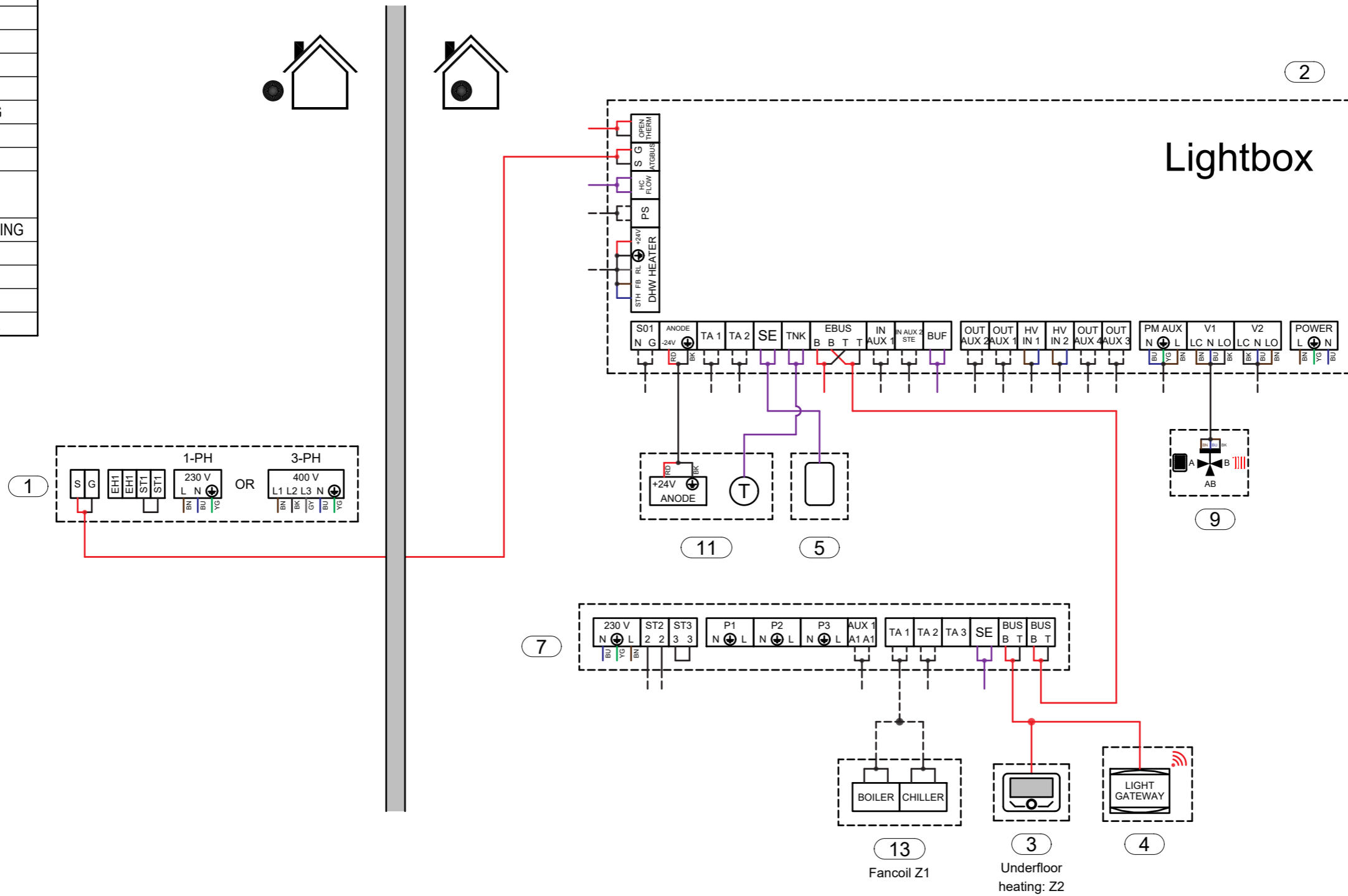













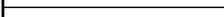

Pos.	Description
1	EXTERNAL UNIT HHP - MONOBLOC 1 -PH OR 3-PH
2	LIGHTBOX
3	SYSTEM INTERFACE
4	LIGHT GATEWAY
5	EXTERNAL PROBE
6	KIT ANTI-FREEZE
7	MGM II HC
8	EXPANSION VESSEL - HEATING
9	HEATING-DHW 3-WAY VALVE
10	DHW INLET SAFETY GROUP
11	DHW TANK HHP 1-COIL WITH T PROBE AND ANODE
12	UNDER FLOOR HEATING-COOLING
13	FANCOIL HEATING-COOLING
14	BY-PASS VALVE
14	HE KIT BELOW ODU
15	THERMOSTATIC MIXING VALVE



- This schematic is for example only and does not replace design by a qualified technician;
- The final schematic must be prepared respecting all the laws, norms and decrees in force, in order to facilitate a correct installation in compliance with the rule of the art;
- For the proper functioning of all system components, follow the instructions in the design, installation and user manuals provided by the manufacturer;
- This outline may be amended by the Ariston Group at any time without prior notice.

SCHEME Electrical		
DATE 19.10.2023.	REV.	PAGE 2 / 3

SCHEME NAME
EN_004_PCM4.PK_HCD_CD1_MGM2_1D.1M

Legend	
Hydraulic	
	Hot water
	Cold water
	DHW hot water
	DHW cold water
	DHW mixed water
	DHW recirculaiton water
	Refrigerant fluid
	Gas connection
	Electric connection
Electric	
	BN Brown (L1)
	BU Blue (N)
	YG yellow green (PE)
	BK black (L2)
	GY Grey (L3)
	RD red
	Dry contact
	BUS connection
	Generic signal
	Sensor signal

- This schematic is for example only and does not replace design by a qualified technician;
- The final schematic must be prepared respecting all the laws, norms and decrees in force, in order to facilitate a correct installation in compliance with the rule of the art;
- For the proper functioning of all system components, follow the instructions in the design, installation and user manuals provided by the manufacturer;
- This outline may be amended by the Ariston Group at any time without prior notice.

SCHEME Legend		
DATE 19.10.2023.	REV.	PAGE 3 / 3

SCHEME NAME EN_004_PCM4.PK_HCD_CD1_MGM2_1D.1M
--

